

Sistema
XP

Sistema XP

Sistema de Portadas

Características do sistema

Sistema de portada que oferece a possibilidade de dois tipos de lâminas:

- Lâminas fixas
- Lâminas orientáveis

As lâminas orientáveis permitem uma total regulação através de mecanismos de rotação que permitem assim um controle da luminosidade de interior.

Este sistema não utiliza inversores graças à fisionomia da folha, utilizando apenas um pequeno perfil de batente.

Perfis de alumínio

As secções do aro e do móvel são de 40 e 47 mm respectivamente, com uma espessura média dos perfis de alumínio de 1.5 mm.

Dimensionamento e manobralidade

Possibilidades de abertura: exterior (1, 2, 3 e 4 folhas), harmónio e correr.

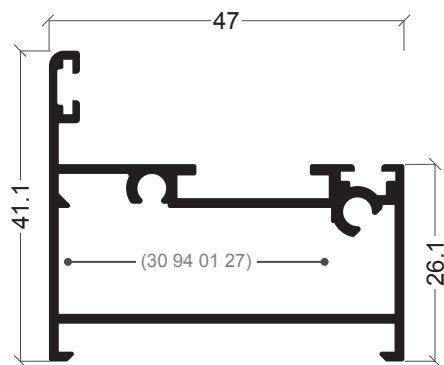

XP-03
Aro fixo

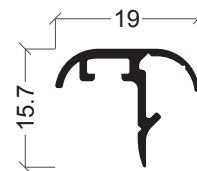

XP-04
Perfil de batente

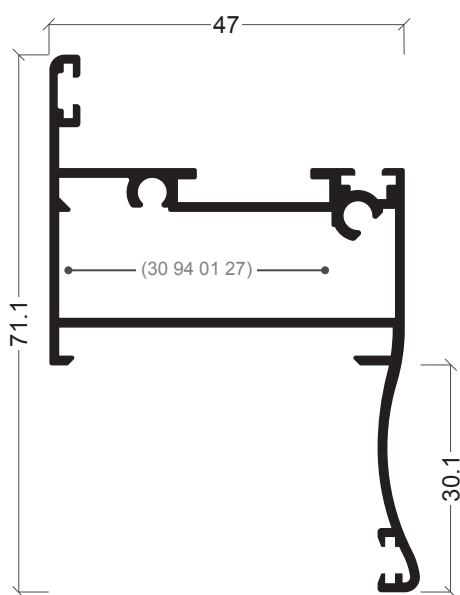

XP-09
Aro fixo com remate

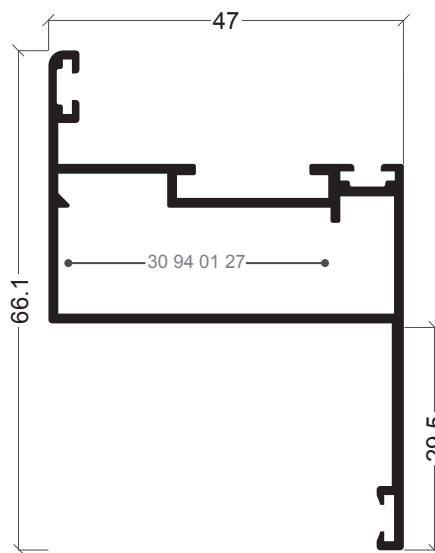

XP-26
Aro fixo com remate

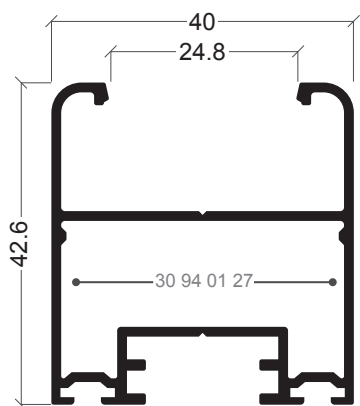

XP-05
Aro móvel

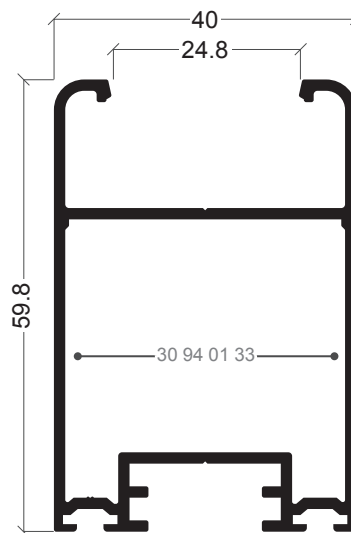

XP-18
Aro móvel

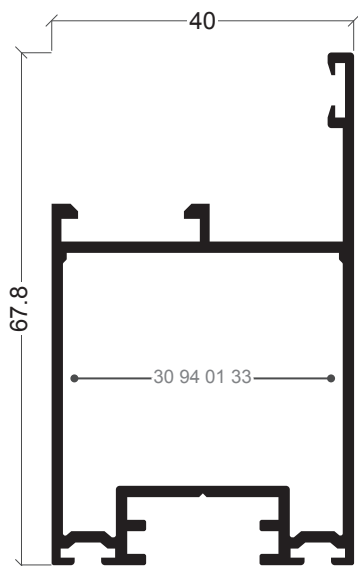

XP-22
Aro móvel com bite

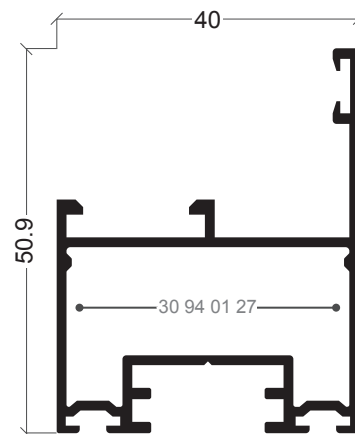

XP-11
Aro móvel com bite

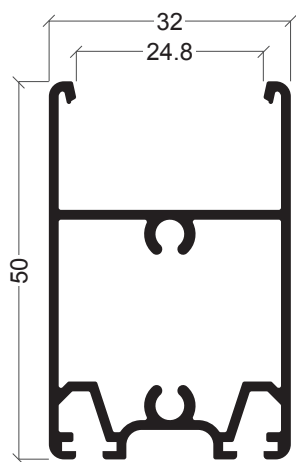

XP-10
Almofada 50 mm

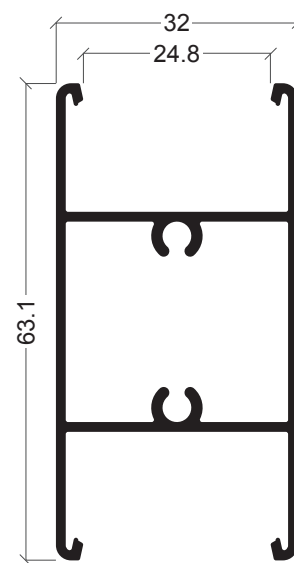

XP-25
Travessa 63 mm

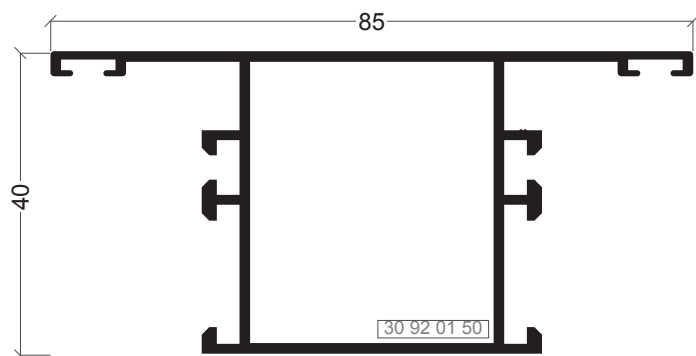

AZ-09
Travessa

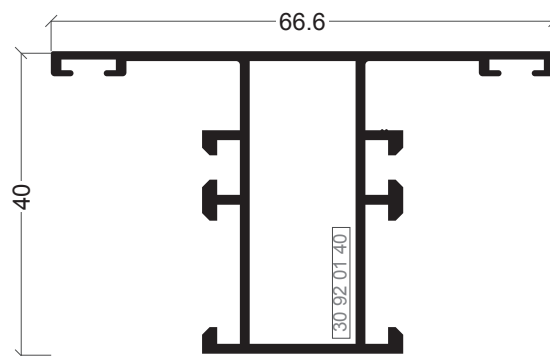

AZ-01
Travessa

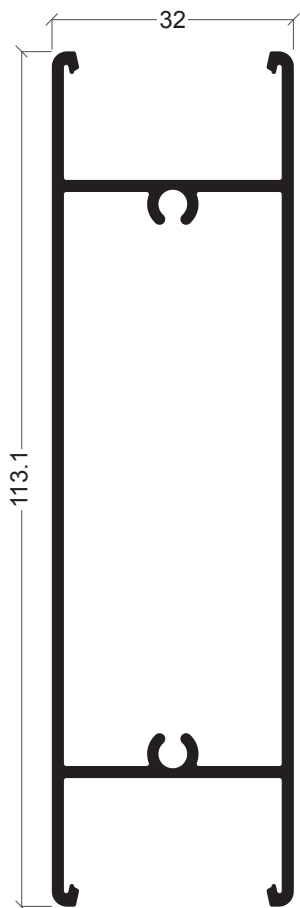

XP-27
Travessa 113 mm

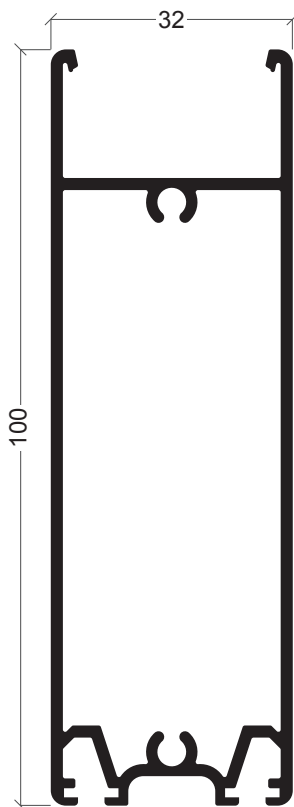

XP-16
Almofada 100 mm

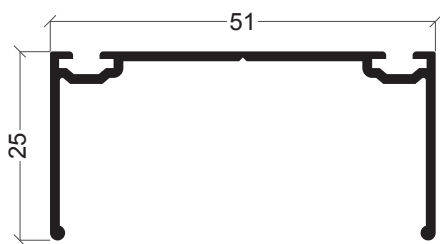

XP-20
Distanciador aro fixo de correr

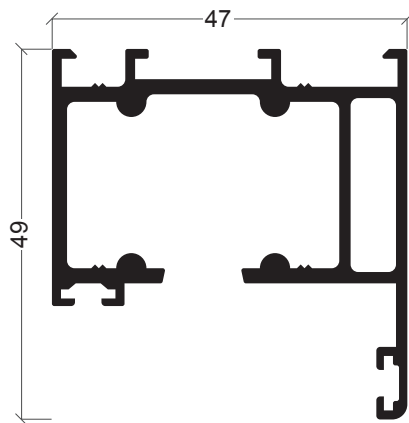

XP-21
Aro fixo de correr

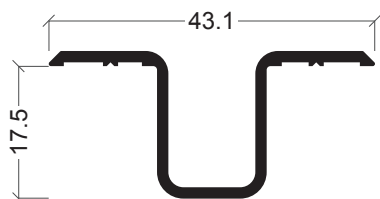

XP-23
Guia embutir de correr

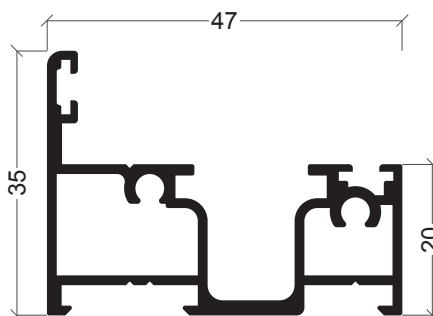

XP-24
Aro fixo guia de correr

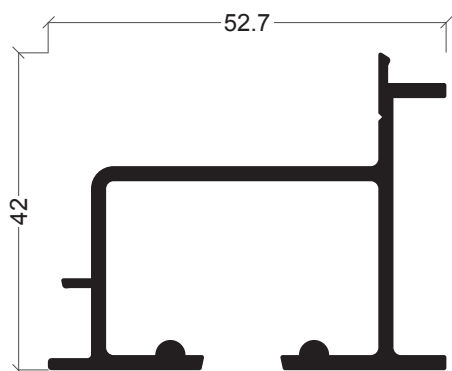

XP-07
Guia superior de correr

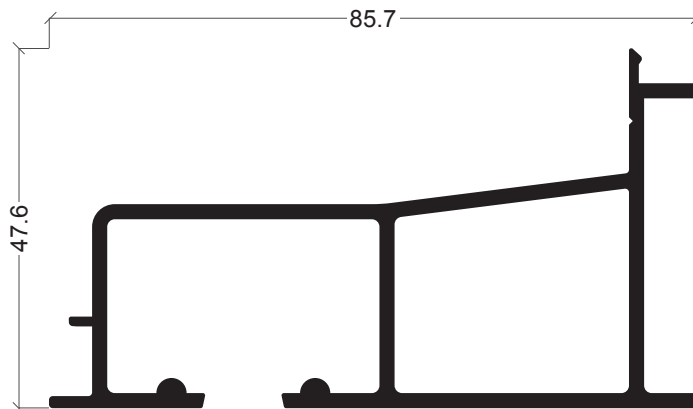

XP-13
Guia superior de correr

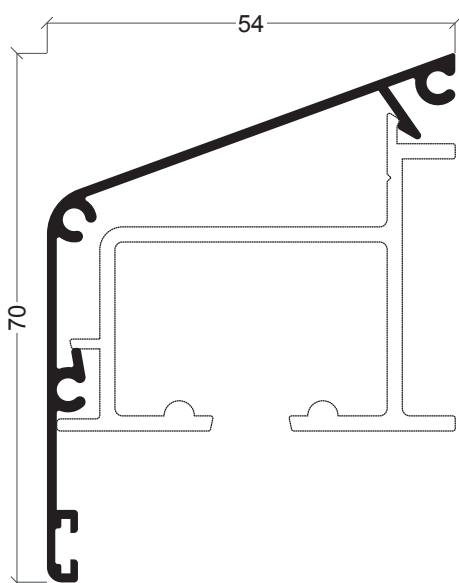

XP-06
Tampa guia superior de correr

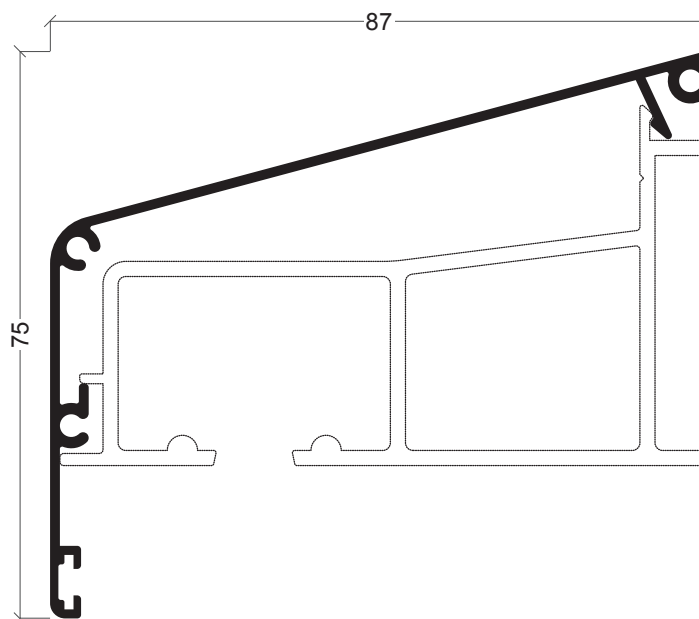

XP-12
Tampa guia superior de correr longa

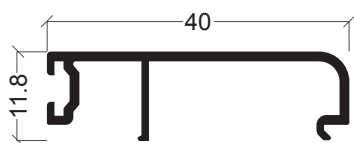

XP-08
Tampa lateral de correr

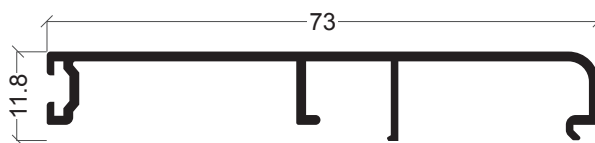

XP-14
Tampa lateral de correr larga

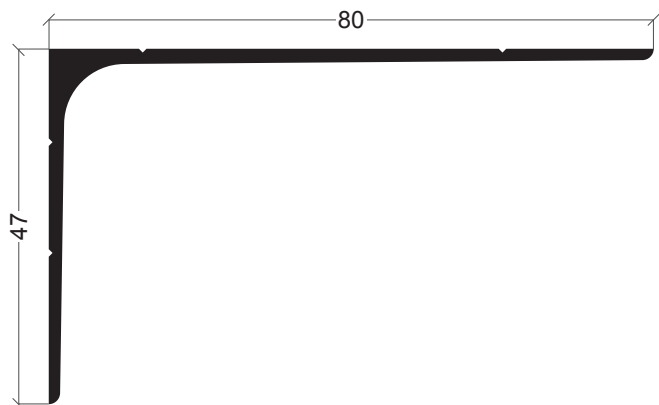

XP-15
Guia inferior de correr

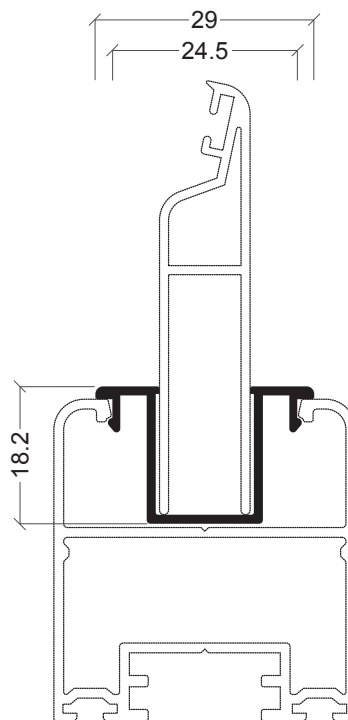

XP-19
Redutor para Z/54

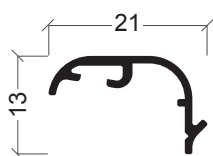

XP-17
Perfil batente de correr



AX-19
Vareta

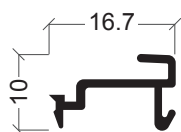

AX-33
Mola Bite

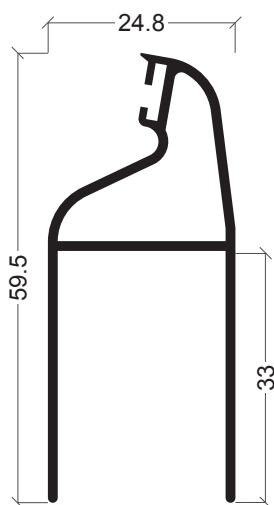

XP-01
Meia lâmina 33 mm

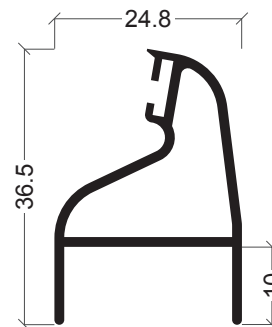

XP-02
Meia lâmina 10 mm

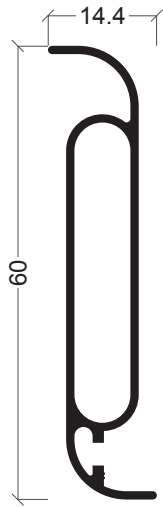

Z-52
Lâmina móvel

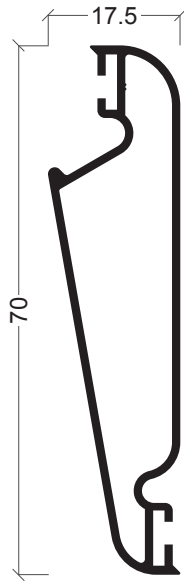

Z-53
Lâmina móvel

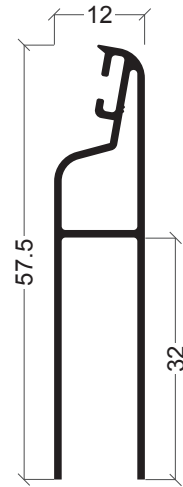

Z-54
Meia lâmina 32 mm

252

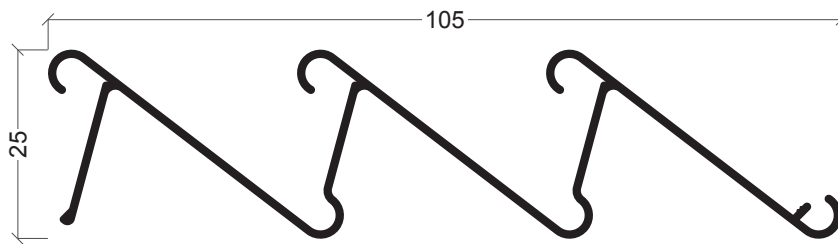

Z-20
Meia lâmina

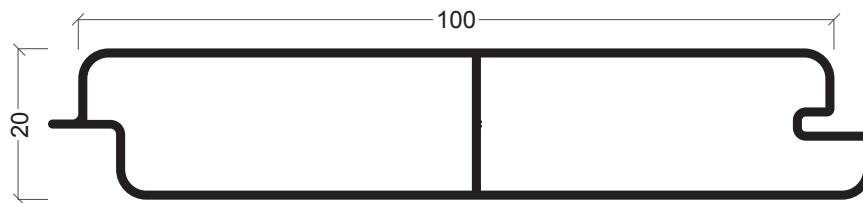

W-25
Lâmina de encaixe 100 x 20

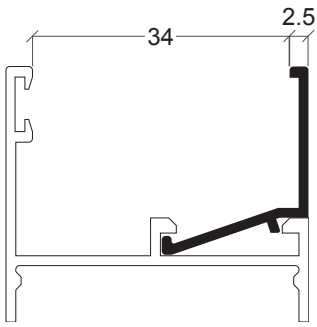

AX-69

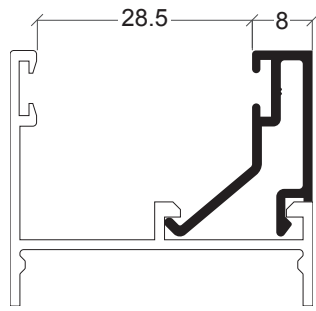

AX-74

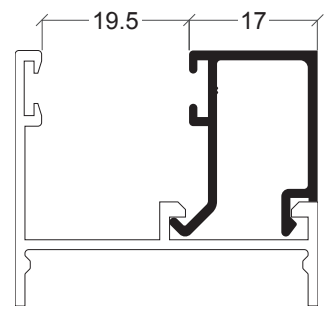

AX-46

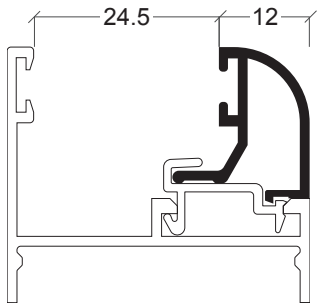

AX-37

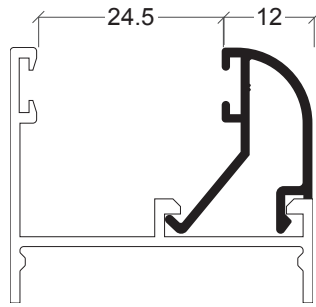

AZ-8

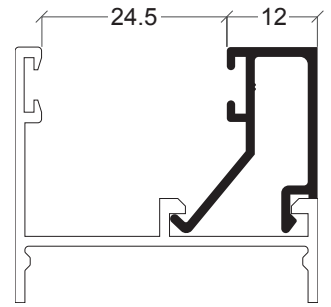

AX-36

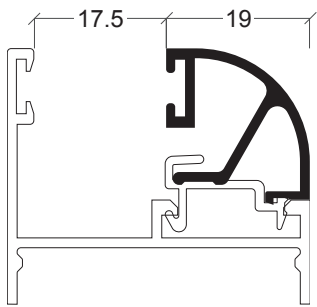

AX-30

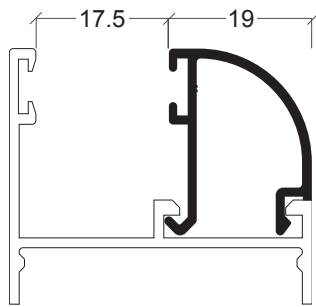

AZ-7

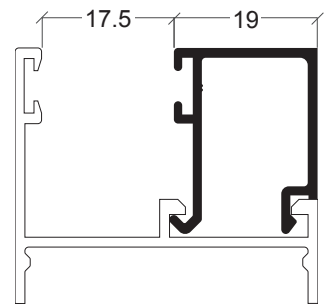

AX-35

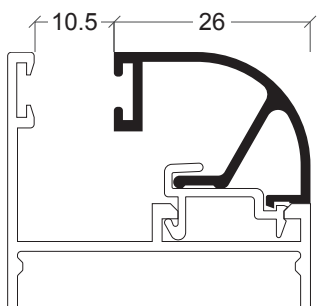

AX-29

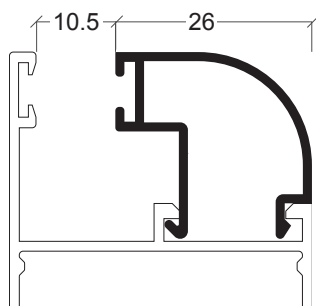

AZ-6

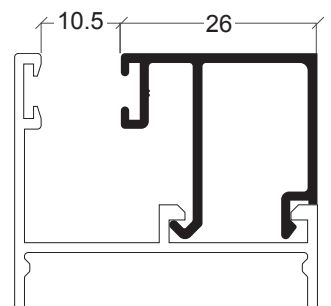

AX-31

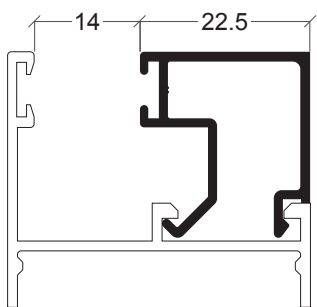

AX-78

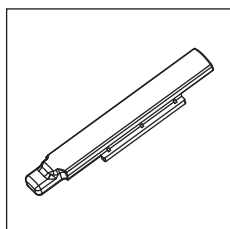

30 92 00 41

Terminal superior

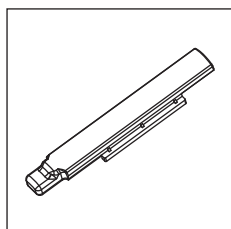

30 92 00 42

Terminal inferior

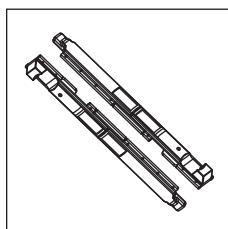

30 92 01 20

Fecho 2ª folha

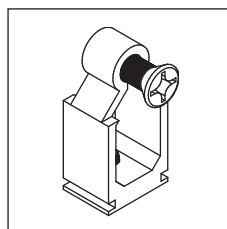

30 92 01 40

União topos janela

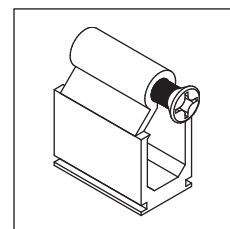

30 92 01 50

União topos porta

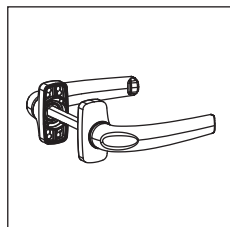

30 92 05 60

Puxador duplo

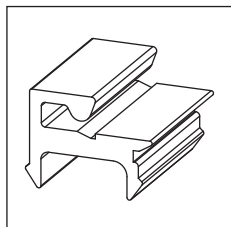

30 94 01 01

Mola bite plástica

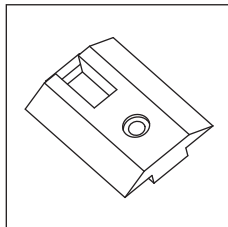

30 94 01 02

Complemento de fecho

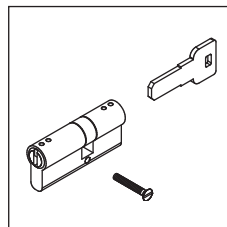

30 94 01 03

Canhão 30x30

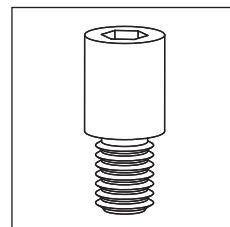

30 94 01 04

Jogo parafusos
distanciadores

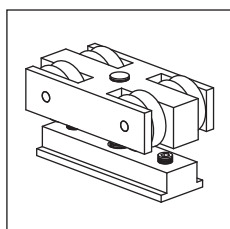

30 94 01 05

Rolamentos

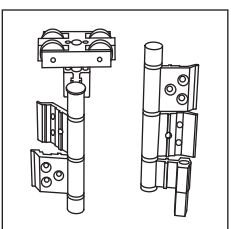

30 94 01 06/14

Rolamento e dobradiça
harmónio (branco/preto)

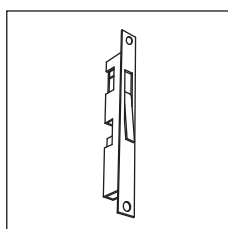

30 94 01 07/15

Fecho de embutir
(branco/preto)

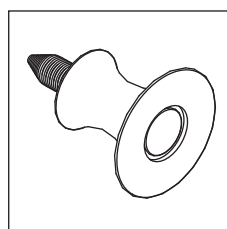

30 94 01 08/16

Aplicador fixador (branco/
preto)

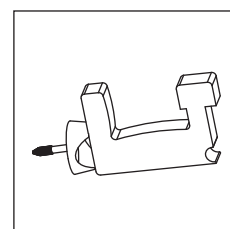

30 94 01 09/17

Fixador de portada 2
folhas (branco/preto)

254

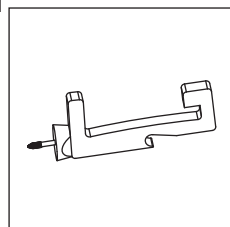

30 94 01 10/18

Fixador portada 4 folhas
(branco/preto)

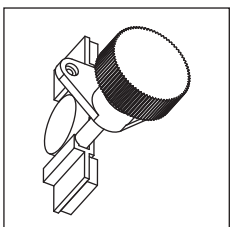

30 94 01 11/19

Comando lâminas
orientáveis (branco/preto)

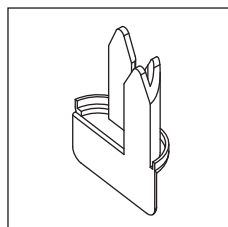

30 94 01 12/20

Jogo topos perfil batente
(branco/preto)

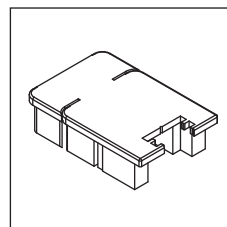

30 94 01 13/21

Tampa aro móvel
(branco/preto)

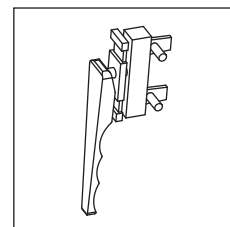

30 94 01 23/29 - 30 94 02 23/29

Cremone 4ª folha direito (branco/
preto) - esquerdo (branco/preto)

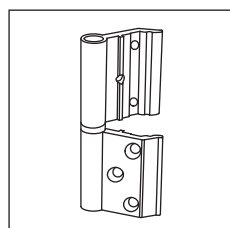

30 94 01 24/30

Dobradiça (branco/preto)

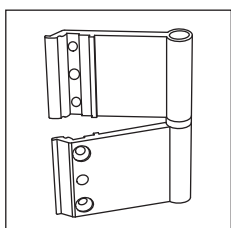

30 94 01 25/31

Dobradiça 4ª folha
(branco/preto)

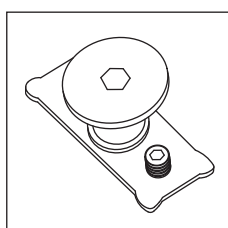

30 94 01 26

Distanciador aro

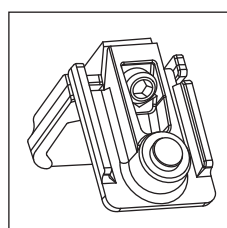

30 94 01 27

Esquadro janela

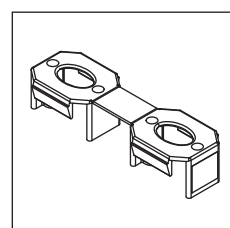

30 94 01 32

Distanciador travessa

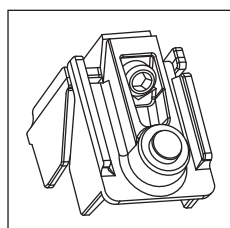

30 94 01 33

Esquadro porta

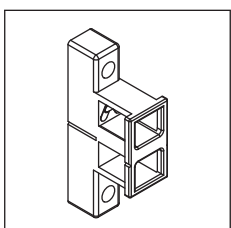

30 94 01 34

Fecho superior correr

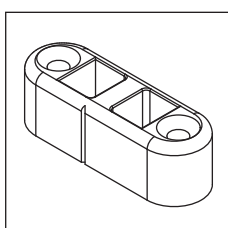

30 94 01 35

Fecho inferior correr

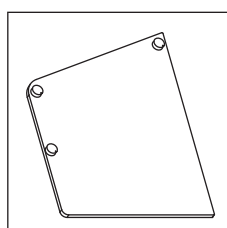

30 94 01 36

Tampa lateral correr
54 mm

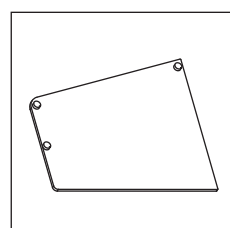

30 94 01 37

Tampa lateral correr
87 mm

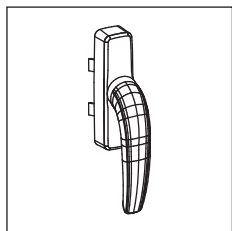

30 94 01 38

Cremona abertura exterior

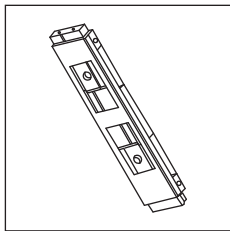

30 94 01 39

Kit fixação cremone abertura exterior

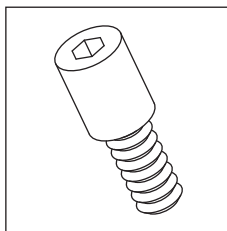

30 94 01 40

Distanciador abertura exterior 14 mm

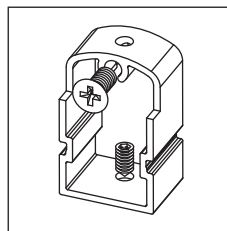

30 94 01 42

Topo travessa XP-10

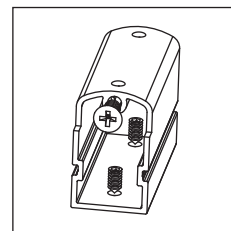

30 94 01 43

Topo travessa XP-16

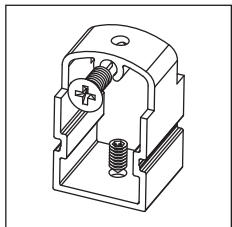

30 94 01 44

União topos janela

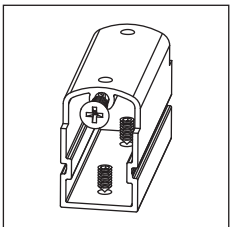

30 94 01 45







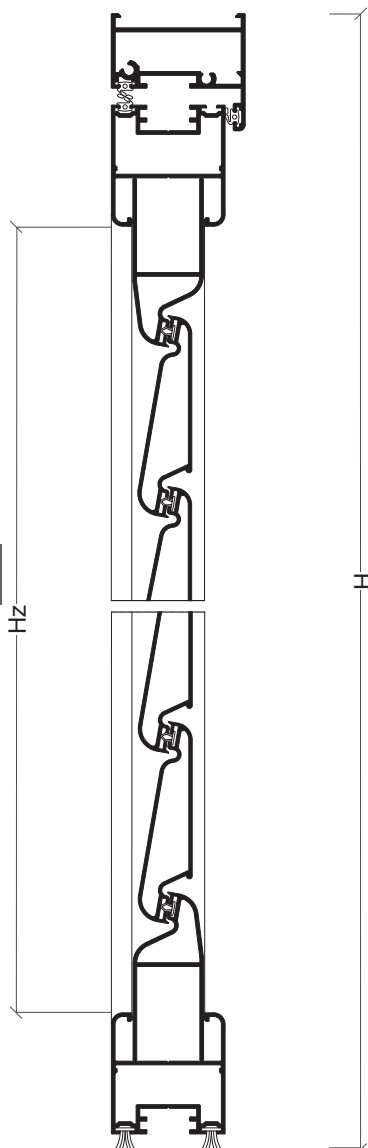
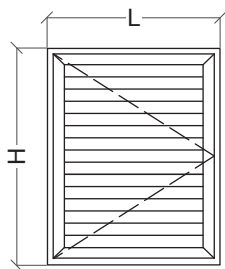

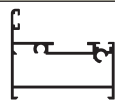

Topo travessa XP-27

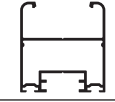
Referência	Desenho	Descrição
30 93 01 40		Junta lâminas
30 94 01 46		Junta interior/exterior
30 95 00 10		Pelúcia 7x9 mm
30 95 00 30		Pelúcia 7x7 mm

Janela 1 folha abertura exterior



Perfis

Desenho	Ref	Descrição	Corte	Quant	Medida
	XP-03	Aro fixo		1	L
				2	H
	XP-05	Aro móvel de janela		2	L-64 mm
				2	H-37 mm
	XP-01	Meia lâmina		2	L-173 mm
	Z-53	Lâmina		Segundo altura	L-163 mm
	AX-19	Vareta		2	Apro. H/2 mm

Acessórios e Juntas

Referência	Descrição	Quantidade
30 94 01 02	Complemento fecho de portada	2
30 94 01 09	Fixador de portada	1
30 94 01 24	Dobradiça branca	2
30 94 01 27	Esquadro de janela	6
30 92 00 41	Terminal de fecho	2
30 94 01 38	Cremona abertura exterior	1
30 94 01 39	Kit fixação cremone	1
30 94 01 40	Distanciador 14 mm abertura exterior	2
---	Jogo portalâminas (segundo altura)	1
30 93 01 40	Vedante lâminas	Nº lâminas + 1L
30 94 01 46	Junta interior/exterior	3L+6H
30 95 00 30	Pelúcia 7x7 mm	2L

Portalâminas



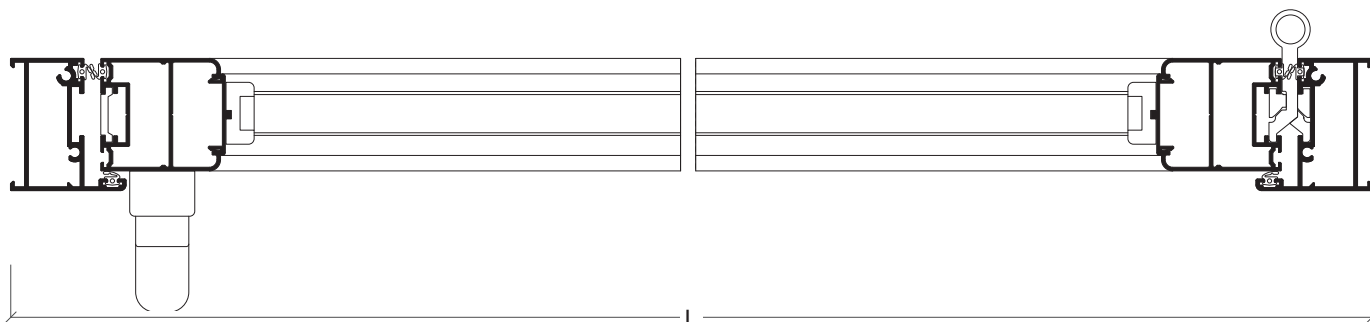



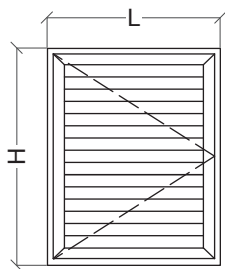

Hz = H-122 mm

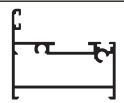

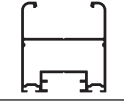
Janela 1 folha abertura exterior - lâminas fixas

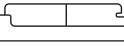

Perfis

Desenho	Ref	Descrição	Corte	Quant	Medida
	XP-03	Aro fixo		1	L
				2	H
	XP-05	Aro móvel de janela		2	L-64 mm
				2	H-37 mm
	W-25	Lâmina		Segundo altura	H-93 mm
	AX-19	Vareta		2	Apro. H/2 mm

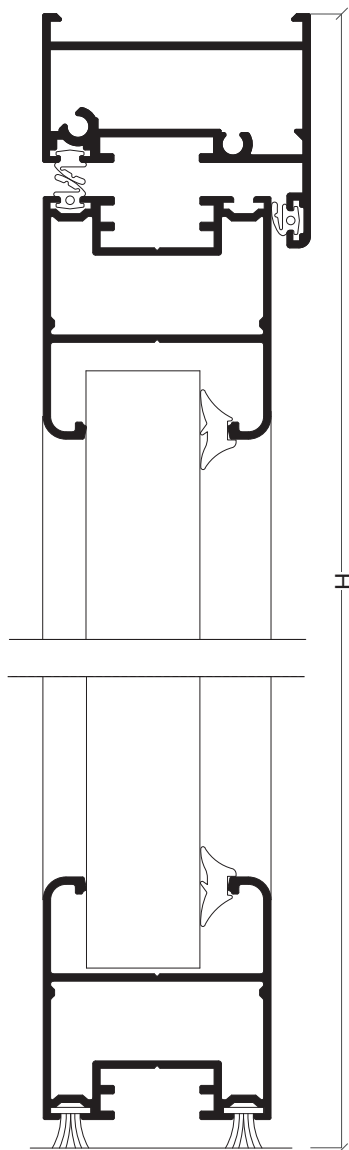

Acessórios e Juntas

Referência	Descrição	Quantidade
30 94 01 02	Complemento fecho de portada	2
30 94 01 09	Fixador de portada	1
30 94 01 24	Dobradiça branca	2
30 94 01 27	Esquadro de janela	6
30 92 00 40	Terminal de fecho	2
30 94 01 38	Cremone abertura exterior	1
30 94 01 39	Kit fixação cremone	1
30 94 01 40	Distanciador 14 mm abertura exterior	2
30 94 01 46	Junta interior/exterior	3L+6H
30 95 00 30	Pelúcia 7x7 mm	2L
30 93 00 65	Junta de cunha	2L+2H

257

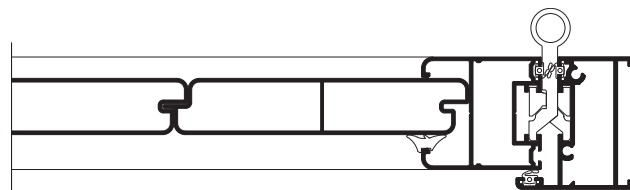
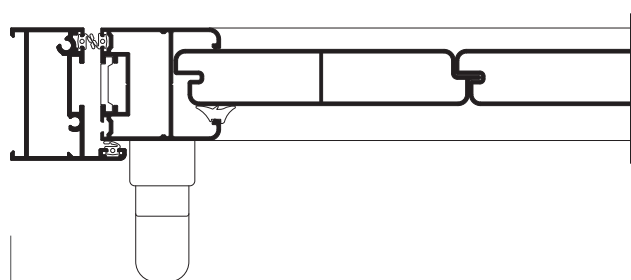

L

Janela 2 folhas abertura exterior

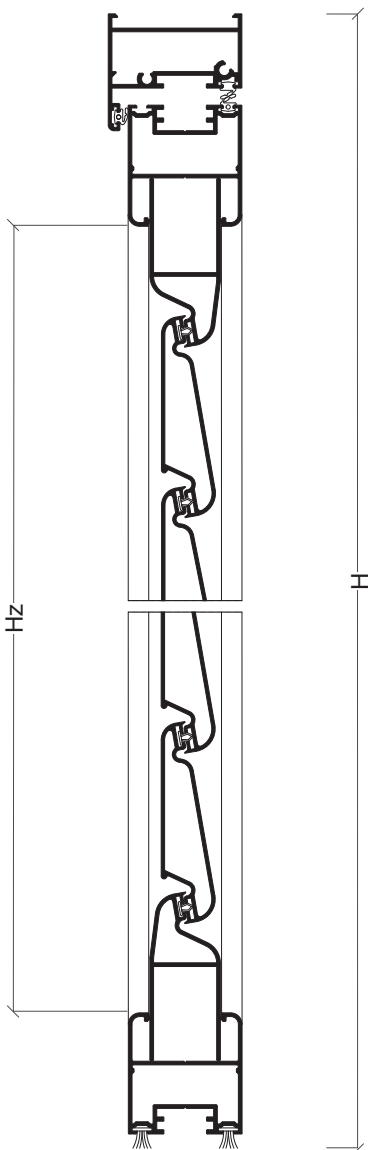
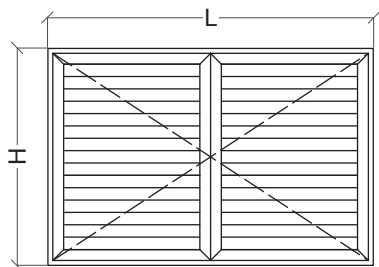

Perfis

Desenho	Ref	Descrição	Corte	Quant	Medida
	XP-03	Aro fixo		1	L
				2	H
	XP-05	Aro móvel de janela		4	L/2-37 mm
				4	H-37 mm
	XP-01	Meia lâmina		4	L/2-144 mm
	Z-53	Lâmina		Segundo altura	L/2-134 mm
	XP-04	Perfil de batente		2	H-37 mm
	AX-19	Vareta		2	Apro. H/2 mm

Acessórios e Juntas

Referência	Descrição	Quantidade
30 92 00 41	Terminal de fecho	2
30 94 01 02	Complemento fecho de portada	2
30 92 01 20	Fecho 2ª folha	2
30 94 01 09	Fixador de portada	2
30 94 01 12	Jogo topos para perfil batente	2
30 94 01 24	Dobradiça	4
30 94 01 27	Esquadro de janela	10
30 94 01 38	Cremone abertura exterior	1
30 94 01 39	Kit fixação cremone	1
30 94 01 40	Distanciador 14 mm abertura exterior	2
---	Jogo portalâminas (segundo altura)	1
30 93 01 40	Vedante lâminas	Nº lâminas + 1 L/2
30 94 01 46	Junta interior/exterior	2L+2L/2+8H
30 95 00 30	Pelúcia 7x7 mm	4L/2

Portalâminas

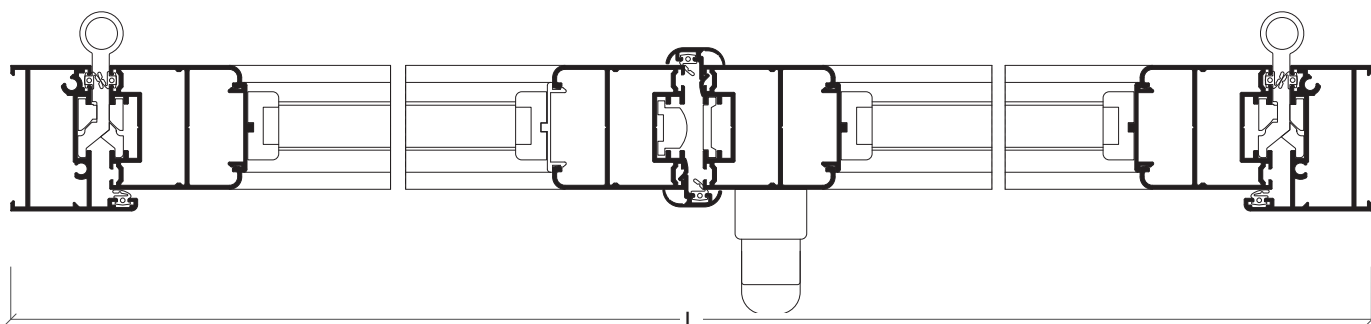

Hz = H-122 mm

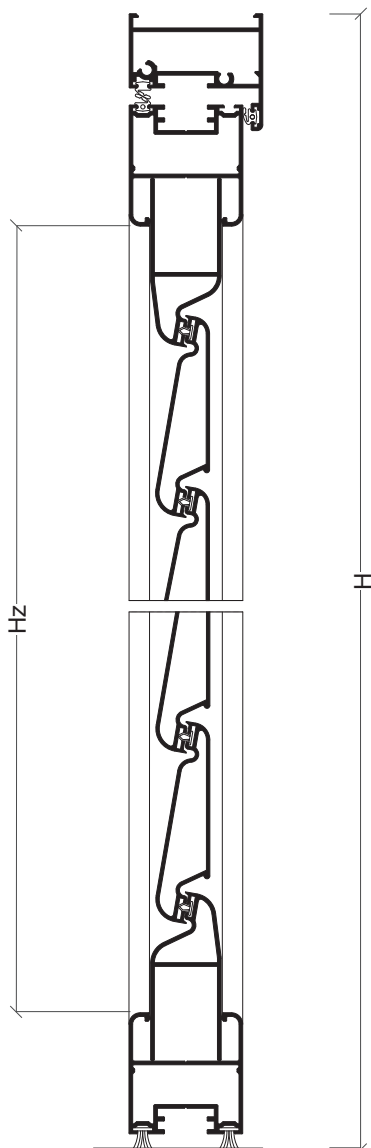
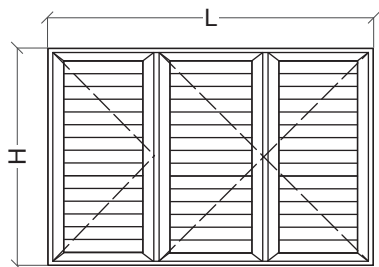

Janela 3 folhas abertura exterior



Perfis

Desenho	Ref	Descrição	Corte	Quant	Medida
	XP-03	Aro fixo		1	L
				2	H
	XP-05	Aro móvel de janela		4	Lat. = L/2-37 mm
				2	Cen. = L/3-42 mm
				6	H-37 mm
	XP-01	Meia lâmina		4	Lat. = L/3-126 mm
				2	Cen. = L/3-151 mm
	Z-53	Lâmina		Segundo altura	Lat. = L/3-116 mm
				Segundo altura	Cen. = L/3-141 mm
	XP-04	Perfil de batente		2	H-37 mm
	AX-19	Vareta		2	Apro. H/2 mm

Acessórios e Juntas

Referência	Descrição	Quantidade
30 92 00 41	Terminal de fecho	2
30 94 01 02	Complemento fecho de portada	4
30 92 01 20	Fecho 2ª folha	4
30 94 01 09	Fixador de portada (opcional)	1
30 94 01 10	Fixador de portada 3/4 folhas (opcional)	1
30 94 01 12	Jogo topos para perfil batente	3
30 94 01 24	Dobradiça	4
30 94 01 25	Dobradiça 3ª/4ª folha	2
30 94 01 27	Esquadro de janela	14
30 94 01 38	Cremone abertura exterior	1
30 94 01 39	Kit fixação cremone	1
30 94 01 40	Distanciador 14 mm abertura exterior	2
---	Jogo portalâminas (segundo altura)	3
30 93 01 40	Vedante lâminas	Nº lâminas + 1 L/3
30 94 01 46	Junta interior/exterior	2L+3L/3+11H
30 95 00 30	Pelúcia 7x7 mm	6L/2

259

Portalâminas

Hz = H-122 mm

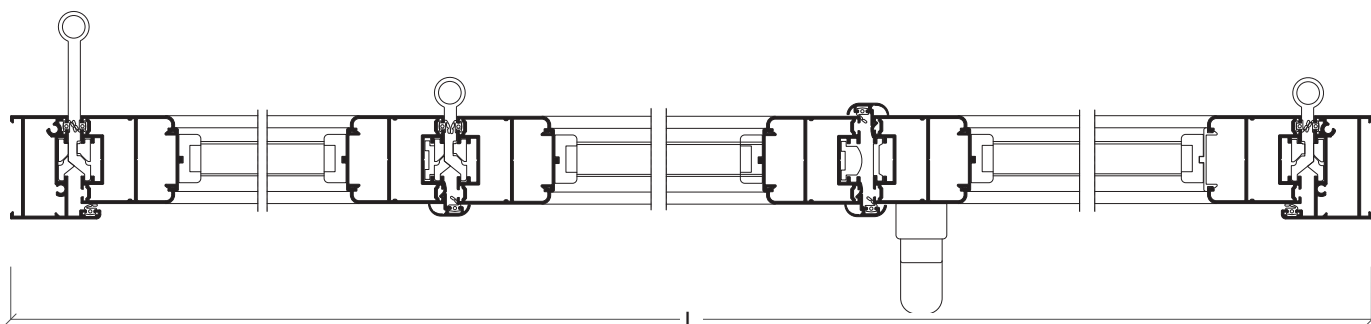

Janela 4 folhas abertura exterior

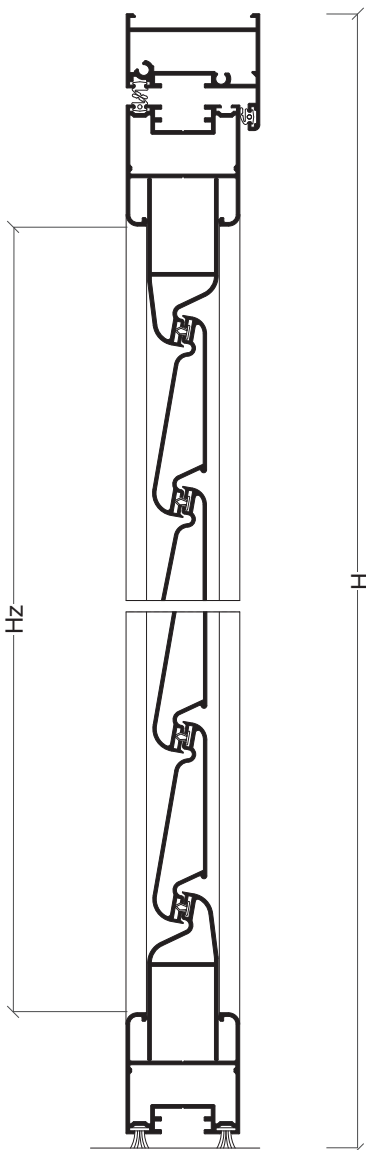
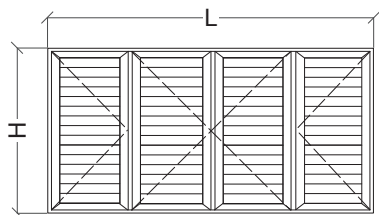

Perfis

Desenho	Ref	Descrição	Corte	Quant	Medida
	XP-03	Aro fixo		1	L
				2	H
	XP-05	Aro móvel de janela		4	Lat. = L/4-8 mm
				4	Cen. = L/4-33 mm
				8	H-37 mm
	XP-01	Meia lâmina		4	Lat. = L/4-117 mm
				4	Cen. = L/4-132 mm
	Z-53	Lâmina		Segundo altura	Lat. = L/4-107 mm
				Segundo altura	Cen. = L/4-132 mm
	XP-04	Perfil de batente		4	H-37 mm
	AX-19	Vareta		2	Apro. H/2 mm

Acessórios e Juntas

Referência	Descrição	Quantidade
30 92 00 41	Terminal de fecho	2
30 94 01 02	Complemento fecho de portada	6
30 92 01 20	Fecho 2ª folha	6
30 94 01 09	Fixador de portada (opcional)	2
30 94 01 10	Fixador de portada 3/4 folhas (opcional)	2
30 94 01 12	Jogo topos para perfil batente	4
30 94 01 24	Dobradiça	4
30 94 01 25	Dobradiça 3ª/4ª folha	4
30 94 01 27	Esquadro de janela	18
30 94 01 38	Cremone abertura exterior	1
30 94 01 39	Kit fixação cremone	1
30 94 01 40	Distanciador 14 mm abertura exterior	2
---	Jogo portalâminas (segundo altura)	4
30 93 01 40	Vedante lâminas	Nº lâminas + 1 L/4
30 94 01 46	Junta interior/exterior	2L+4L/4+14H
30 95 00 30	Pelúcia 7x7 mm	8L/4

Portalâminas

Hz = H-122 mm

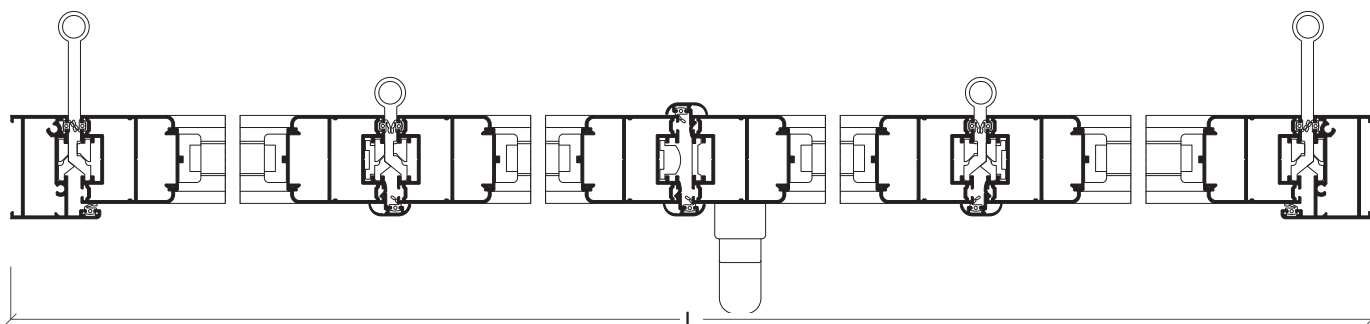

Porta 2 folhas abertura exterior

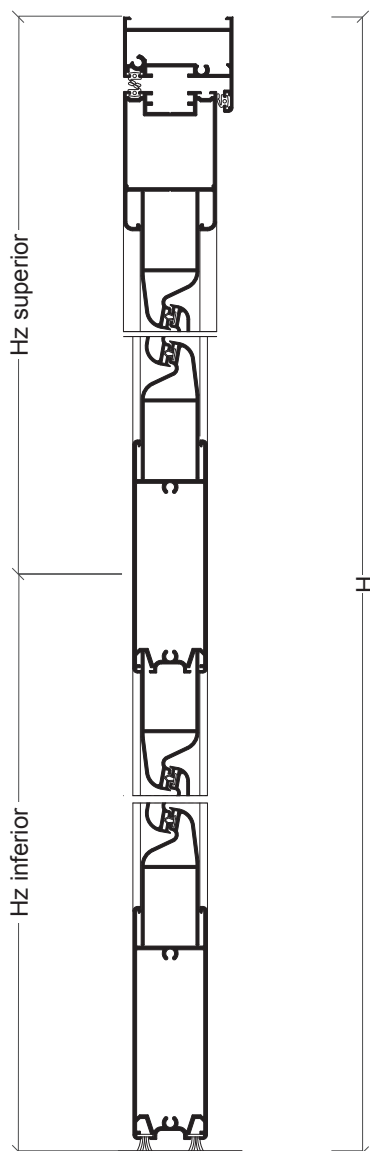
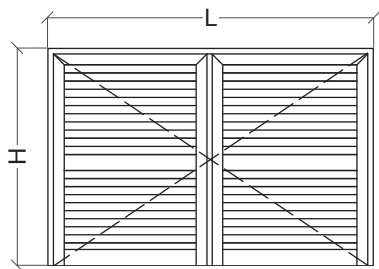

Perfis

Desenho	Ref	Descrição	Corte	Quant	Medida
	XP-03	Aro fixo		1	L
				2	H
	XP-18	Aro móvel de porta		2	L/2-35 mm
				4	H-37 mm
	XP-16	Almofada 100 mm		4	L/2-154 mm
	XP-01	Meia lâmina		8	L/2-178 mm
	Z-53	Lâmina		Segundo altura	L/2-168 mm
	XP-04	Perfil de batente		2	H-37 mm
	AX-19	Vareta		2	Apro. H/2 mm

Acessórios e Juntas

Referência	Descrição	Quantidade
30 94 01 38	Cremona abertura exterior	1
30 94 01 02	Complemento fecho de portada	2
30 94 01 39	Kit fixação cremona	1
30 94 01 12	Jogo topos para perfil batente	2
30 94 01 13	Tampa da folha	4
30 94 01 24	Dobradiça	8
30 94 01 27	Esquadro de janela	2
30 94 01 32	Distanciador de travessa	8
30 94 01 33	Esquadro porta	4
30 92 02 40	Fecho 2ª folha	6
30 94 01 40	Distanciador 14 mm abertura exterior	2
30 92 05 60	Puxador duplo	1
---	Jogo portalâminas (segundo Hz superior)	2
---	Jogo portalâminas (segundo Hv inferior)	2
30 93 01 40	Vedante lâminas	Nº lâminas + 2 L/2
30 94 01 46	Junta interior/exterior	2L+2L/2+8H
30 95 00 30	Pelúcia 7x7 mm	4L/2

Portalâminas

Hz superior = H1-148 mm
Hv inferior = H2-161 mm

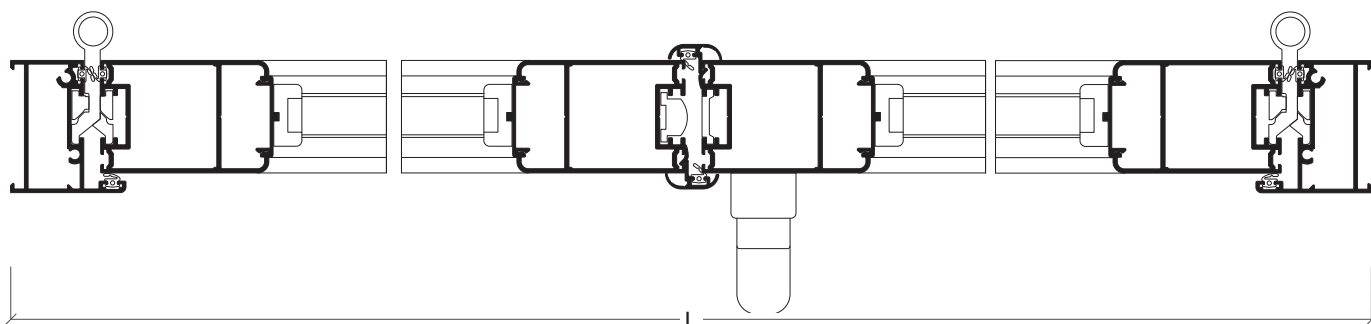

Porta 3 folhas harmónio abertura exterior

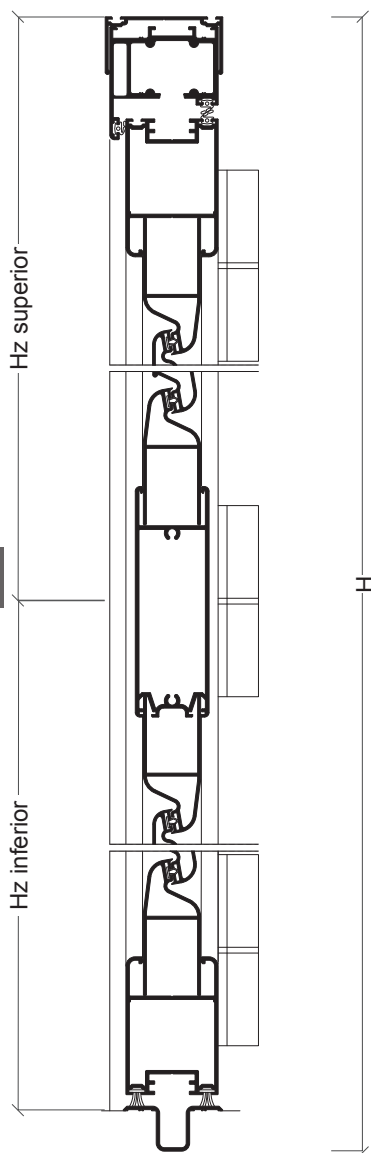
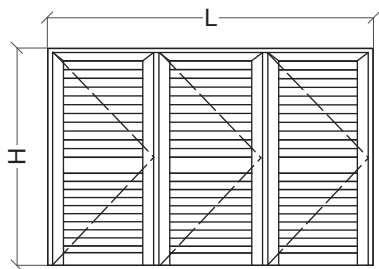

Perfis

Desenho	Ref	Descrição	Corte	Quant	Medida
	XP-20	Distanciador de aro		1	L
	XP-21	Aro fixo para carril		1	L
	XP-03	Aro fixo		2	H-31 mm
	XP-18	Aro móvel de porta		6	L/3-25 mm
				6	H-47 mm
	XP-16	Almofada 100 mm		3	L/3-145 mm
	XP-01	Meia lâmina		12	L/3-168 mm
	Z-53	Lâmina		Segundo altura	L/3-158 mm
	XP-23	Guia de embutir		1	L
	AX-19	Vareta		2	Apro. H

Dimensões máximas: 800x2500 mm por folha
Peso máximo: 40 Kg por folha

Acessórios e Juntas

Referência	Descrição	Quantidade
30 94 01 04	Jogo parafusos distanciadores	2
30 94 01 07	Fecho de embutir portada	2
30 94 01 08	Aplique fixador	2
30 94 01 06	Rolamentos/dobradiças harmónio	1
30 94 01 23	Cremona 4 folhas (opcional a A)	2
30 94 01 24	Dobradiça	8
30 94 01 26	Distanciador de pavimento	4
30 94 01 32	Distanciador chão	8
30 94 01 33	Esquadro porta	12
30 92 00 41	Terminal fecho	2
30 92 00 42	Terminal fecho inferior	2
---	Jogo portalâminas (segundo Hz superior)	3
---	Jogo portalâminas (segundo Hz inferior)	3
30 93 01 40	Vedante lâminas	Nº lâminas + 2 L/3
30 94 01 46	Junta interior/exterior	2L+3L/3+14H
30 95 00 30	Pelúcia 7x7 mm	6L/3

Portalâminas



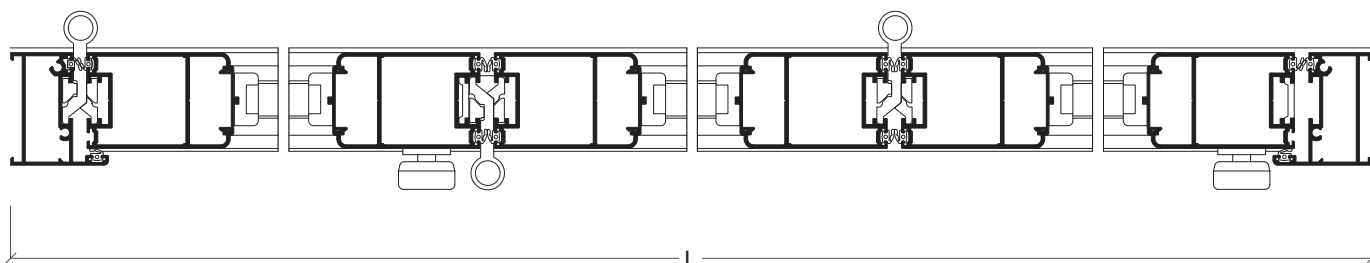



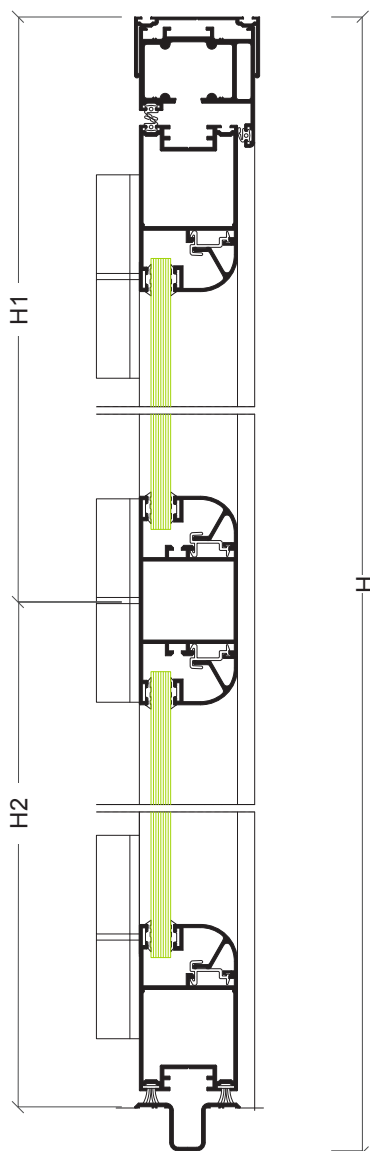
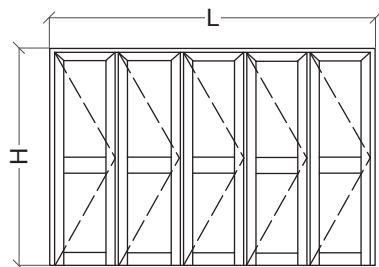















Hz superior = H1-156 mm
Hz inferior = H2-123 mm



Porta 5 folhas harmónio abertura exterior com vidro



Perfis

Desenho	Ref	Descrição	Corte	Quant	Medida
	XP-20	Distanciador de aro		1	L
	XP-21	Aro fixo para carril		1	L
	XP-03	Aro fixo		2	H-31 mm
	XP-22	Aro móvel de porta		10	L/5-17 mm
				10	H-47 mm
	AZ-09	Travessa		5	L/5-103 mm
	AZ-06	Bite redondo		10	H1-100 mm
				10	H2-67 mm
	AX-29	Bite redondo		20	L/5-113 mm
	AX-33	Mola bite		A cada 300 mm	80 mm
	XP-23	Guia de embutir		1	L
	AX-19	Vareta		2	Apro. H

Dimensões máximas: 800x2500 mm por folha
 Peso máximo: 40 Kg por folha

Acessórios e Juntas

Referência	Descrição	Quantidade
30 94 01 04	Jogo parafusos distanciadores	3
30 94 01 07	Fecho de embutir portada	3
30 94 01 08	Aplique fixador	3
30 94 01 06	Rolamentos/dobradiças harmónio	2
30 94 01 23	Cremona 4 folhas (opcional a A)	3
30 94 01 24	Dobradiça	11
30 94 01 26	Distanciador de aro	1 a cada 50 cm
30 94 01 33	Esquadro porta	20
30 92 00 41	Terminal fecho	3
30 92 00 42	Terminal fecho inferior	3
30 92 01 50	União topos porta	10
30 94 01 46	Junta interior/exterior	2L+5L/5+22H
30 95 00 30	Pelúcia 7x7 mm	10L/5
---	Junta exterior vidro	4L+10H
---	Junta interior vidro	4L+10H

Vidros



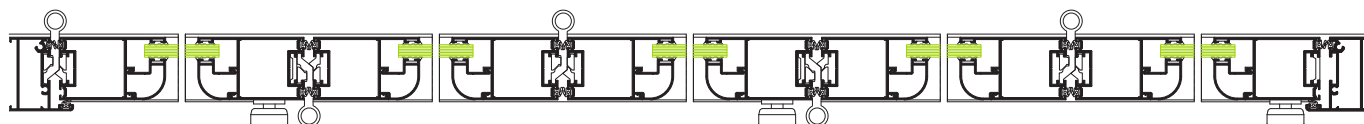



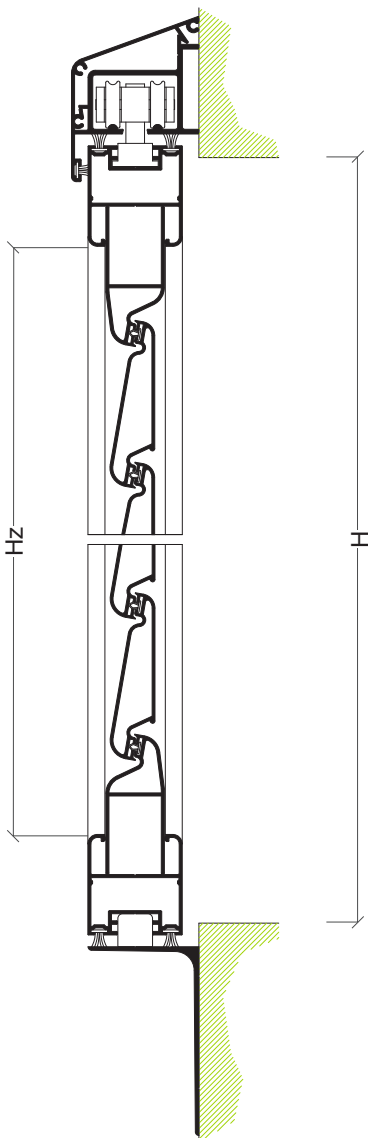
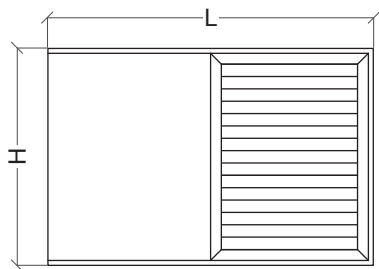









L/5-126 mm	H1-123 mm
L/5-126 mm	H2-90 mm



Janela 1 folha correr



Perfis

Desenho	Ref	Descrição	Corte	Quant	Medida
	XP-07	Guia superior de correr		1	2L+59 mm
	XP-05	Aro móvel de janela		2	L+10 mm
				2	L+10 mm
	XP-01	Meia lâmina		2	L-99 mm
	Z-53	Lâmina		Segundo altura	L-89 mm
	AX-19	Vareta		2	Apro. H/2 mm
	XP-06	Tampa da guia superior		1	2L+59 mm
	XP-08	Tampa lateral de correr		2	H+10 mm
	XP-15	Guia inferior de correr		1	2L+59 mm

Acessórios e Juntas

Referência	Descrição	Quantidade
30 94 01 04	Jogo parafusos distanciadores	1
30 94 01 05	Rolamentos portada de correr	2
30 94 01 07	Fecho de embutir portada	1
30 94 01 27	Esquadro de janela	4
30 94 01 34	Fecho superior correr	2
30 94 01 35	Fecho inferior correr	2
30 94 01 36	Tampa lateral	2
30 92 00 41	Terminal fecho	2
---	Jogo portalâminas (segundo altura)	1
30 93 01 40	Vedante lâminas	Nº lâminas + 1 L
30 95 00 10	Pelúcia 7x9 mm	4L+2H+12L

Portalâminas

Hz = H-75 mm

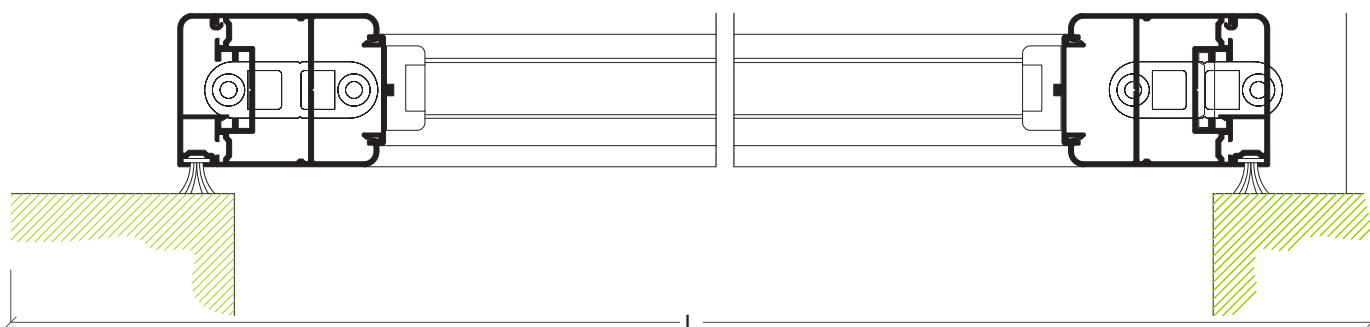

Janela 2 folhas correr

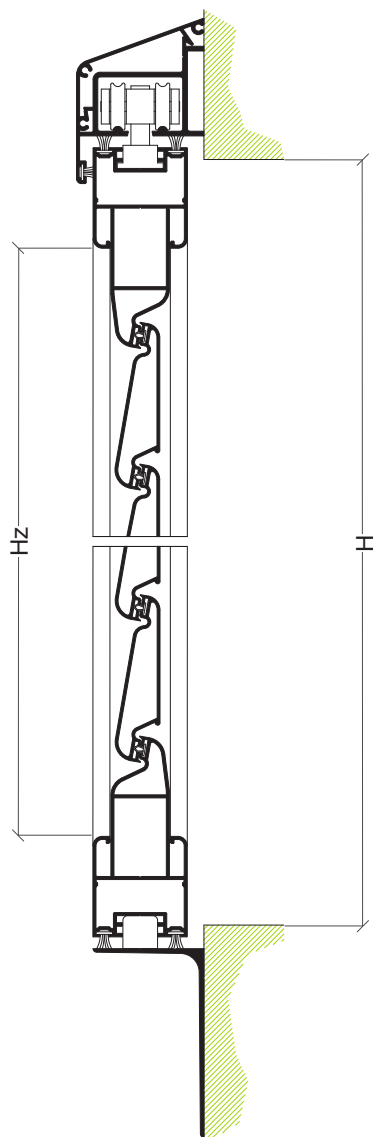
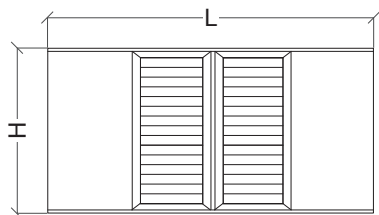

Perfis

Desenho	Ref	Descrição	Corte	Quant	Medida
	XP-07	Guia superior de correr		1	2L+19 mm
	XP-05	Aro móvel de janela		4	L/2 mm
				4	H+10 mm
	XP-01	Meia lâmina		4	L/2-109 mm
	Z-53	Lâmina		Segundo altura	L/2-99 mm
	AX-19	Vareta		2	Apro. H/2 mm
	XP-06	Tampa da guia superior		1	2L+19 mm
	XP-08	Tampa lateral de correr		2	H+10 mm
	XP-15	Guia inferior de correr		1	2L+19 mm
	XP-17	Perfil de batente		2	H-7 mm

Acessórios e Juntas

Referência	Descrição	Quantidade
30 94 01 04	Jogo parafusos distanciadores	2
30 94 01 05	Rolamentos portada de correr	4
30 94 01 07	Fecho de embutir portada	2
30 94 01 12	Jogo topos para perfil batente	2
30 94 01 27	Esquadro de janela	8
30 94 01 34	Fecho superior correr	3
30 94 01 35	Fecho inferior correr	3
30 94 01 36	Tampa lateral	2
30 92 00 41	Terminal fecho	4
---	Jogo portalâminas (segundo altura)	2
30 93 01 40	Vedante lâminas	Nº lâminas + L/2
30 95 00 10	Pelúcia 7x9 mm	8L/2+4H+12L

265

Portalâminas

Hz = H-75 mm

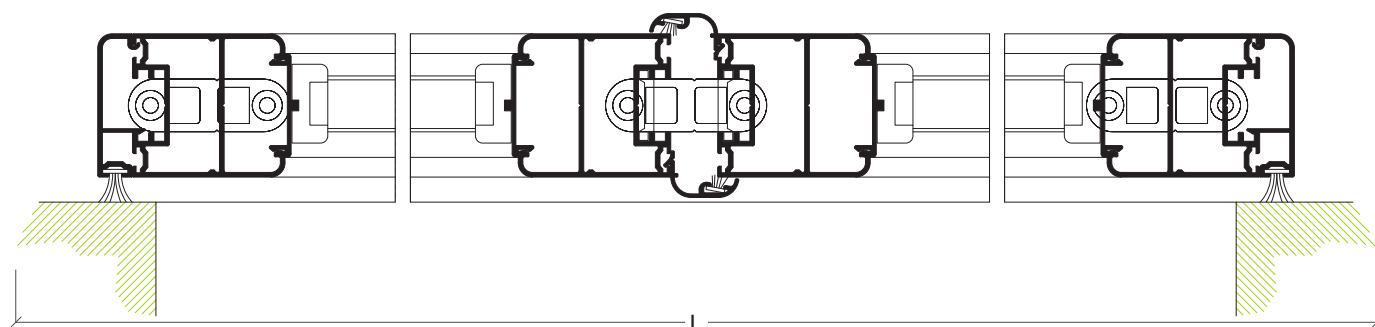

Janela 2 folhas correr afastada

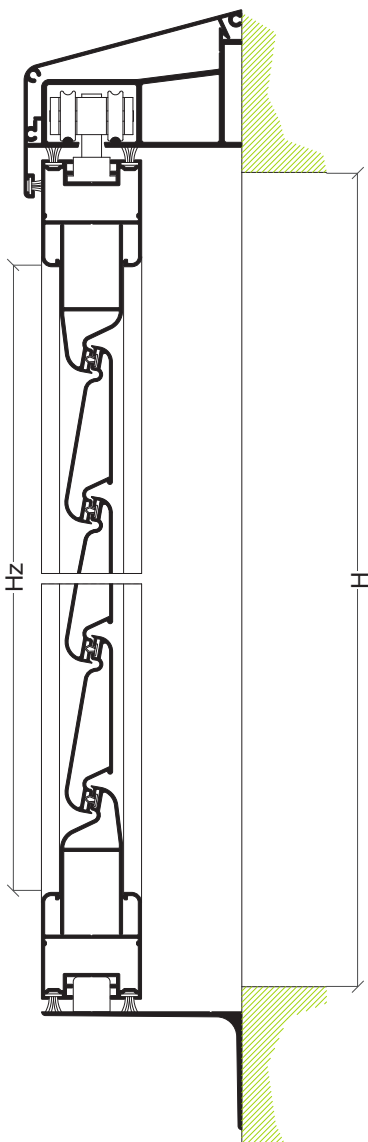
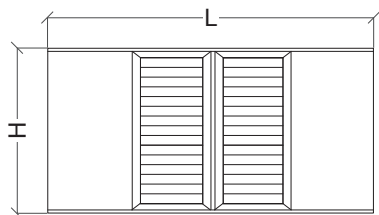

Perfis

Desenho	Ref	Descrição	Corte	Quant	Medida
	XP-13	Guia superior de correr larga		1	2L+19 mm
	XP-05	Aro móvel de janela		4	L/2 mm
				4	H+10 mm
	XP-01	Meia lâmina		4	L/2-109 mm
	Z-53	Lâmina		Segundo altura	L/2-99 mm
	AX-19	Vareta		2	Apro. H/2 mm
	XP-12	Tampa guia superior larga		2	2L+19 mm
	XP-14	Tampa lateral de correr larga		2	H+10 mm
	XP-15	Guia inferior de correr		1	2L+19 mm
	XP-17	Perfil de batente		2	H-7 mm

Acessórios e Juntas

Referência	Descrição	Quantidade
30 94 01 04	Jogo parafusos es	2
30 94 01 05	Rolamentos portada de correr	4
30 94 01 07	Fecho de embutir portada	2
30 94 01 12	Jogo topos para perfil batente	2
30 94 01 27	Esquadro de janela	8
30 94 01 34	Fecho superior correr	3
30 94 01 35	Fecho inferior correr	3
30 94 01 36	Tampa lateral	2
30 92 00 41	Terminal fecho	4
---	Jogo portalâminas (segundo altura)	2
30 93 01 40	Vedante lâminas	Nº lâminas + L/2
30 95 00 10	Pelúcia 7x9 mm	8L/2+4H+12L

Portalâminas

Hz = H-75 mm

